

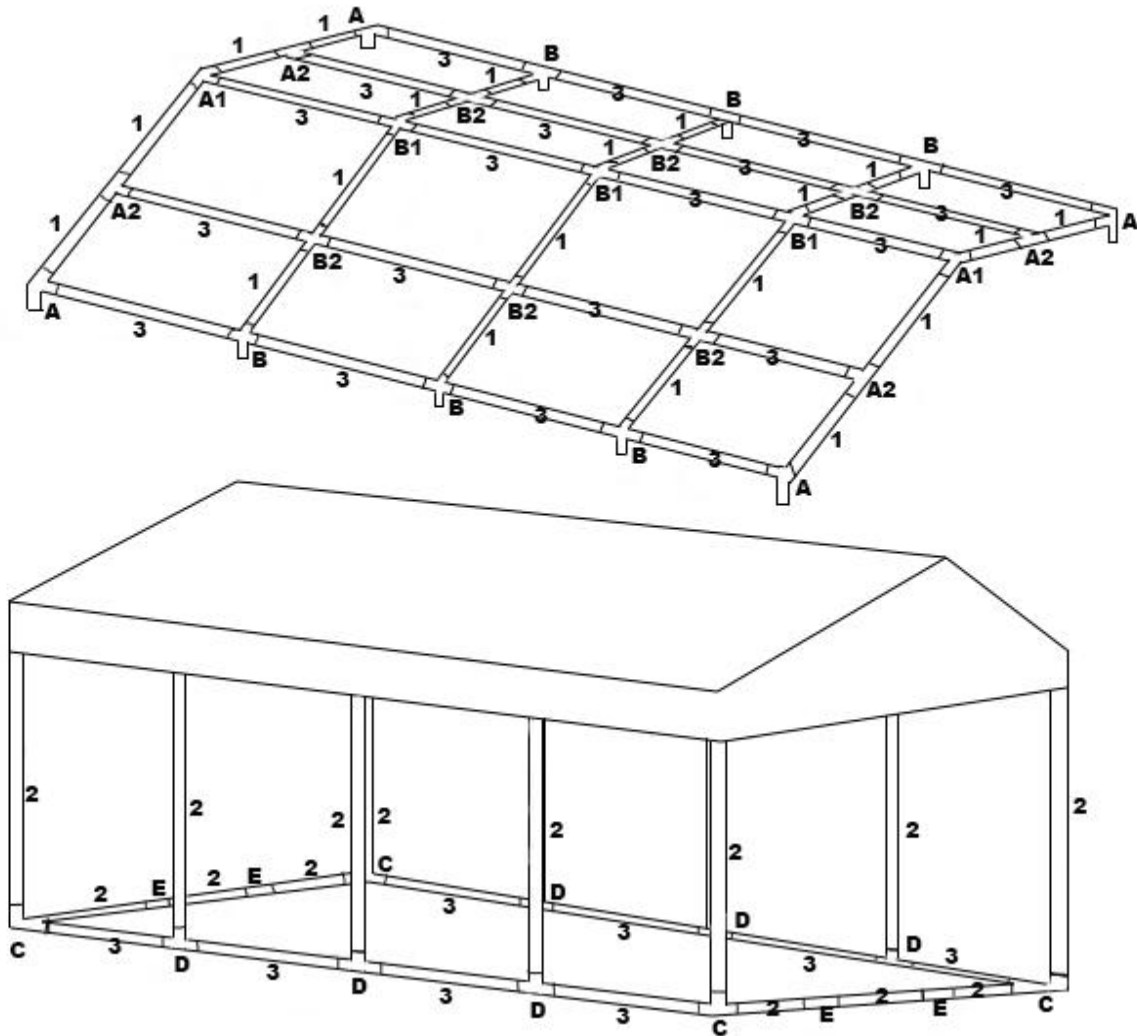







# THE INSTALL INSTRUCTION FOR 6×9M PVC PARTY TENTS

## PARTY TENTS

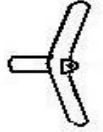
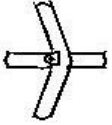
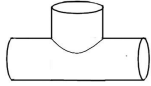
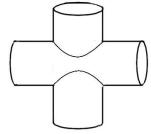
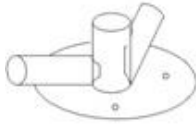
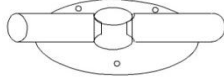

No.	Tube Descriptions	Graph	Quantity
1#	1570mm Galvanized Pipe		20
2#	1930mm Galvanized Pipe (leg tubes)		16
3#	2140mm Galvanized Pipe		28
	1500mm Reinforced bar on top part		10
	800mm Reinforced bar on top part		5

No.	Joint descriptions	Graph	Quantity
A	120° 3 Way joint		4

<b>B</b>	120° 4 Way joints		<b>6</b>
<b>A1</b>	120° 3 Way joints		<b>2</b>
<b>B1</b>	120° 4 Way joints		<b>3</b>
<b>A2</b>	Flat 3 Way joints		<b>4</b>
<b>B2</b>	Flat 4 Way joints		<b>6</b>
<b>C</b>	90° 3 Way joints (foot plate)		<b>4</b>
<b>D</b>	180° 3 Way joints (foot plate)		<b>6</b>
<b>E</b>	2 way joints for front and back door		<b>4</b>
<b>F</b>	Ropes		<b>4</b>
<b>G</b>	Ground Nails(4mm×18mm)		<b>10</b>
<b>H</b>	Ground Nails(6mm×18mm)		<b>4</b>
<b>I</b>	Screws		<b>20</b>
<b>J</b>	Bungee balls with elastic ropes		<b>150</b>

K	Install Instruction		1
---	---------------------	--	---

## 6×9M STRUCTURE TENT

### Frame Assembly

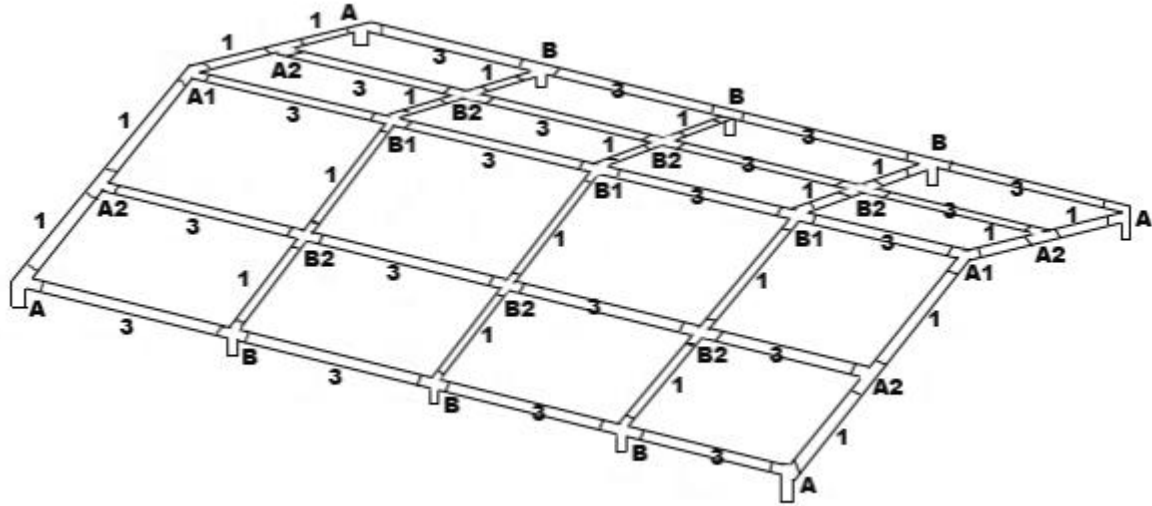

1. Place all joints, 1570mm pipes and 1930mm pipes on the ground as shown. Push two pipes into the joints, use buttons to fix them.

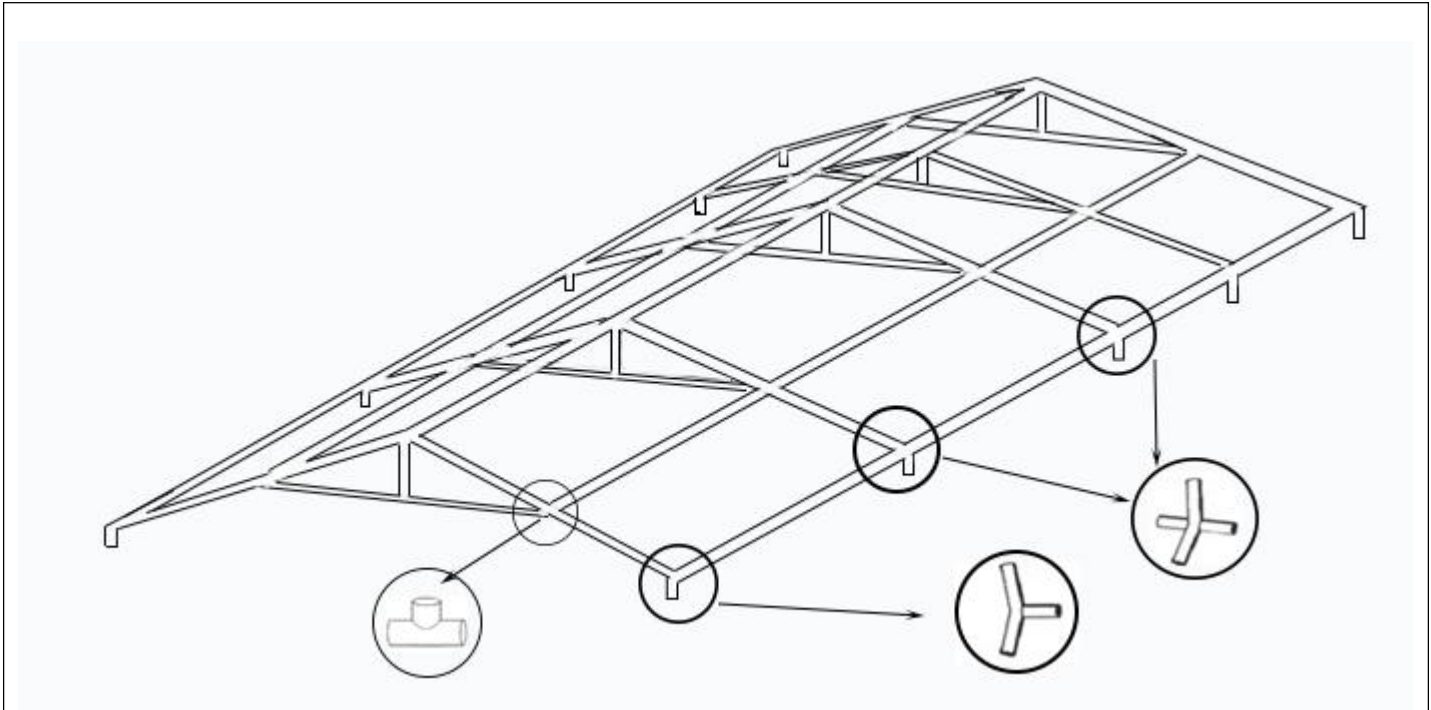

Connect reinforced bars together with bungee balls.

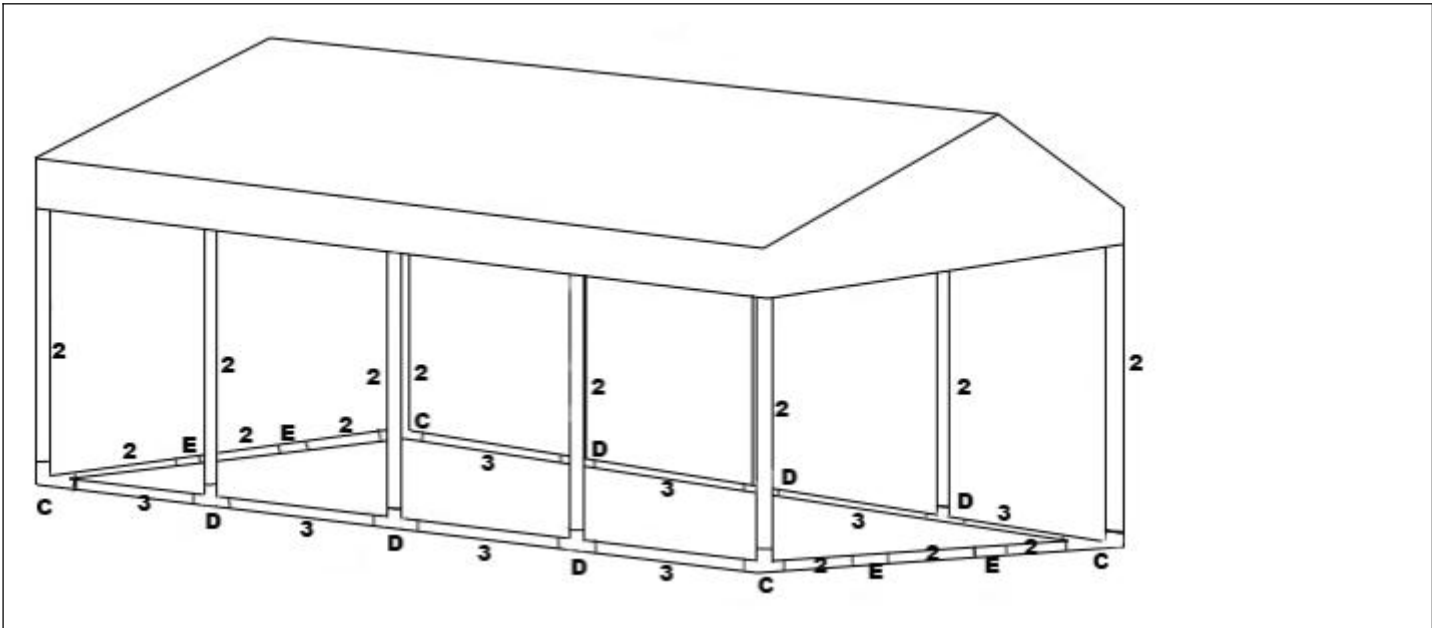

4. Insert leg tubes and connect the legs with ground bars.